



Concept Pro

5MP	2.8mm Fixed Lens F1.0 Super Aperture	24/7 Full Colour	IP
------------	---	-------------------------	-----------

ColourSmart

CVP9316DLCS-IP5M/2.8

Concept Pro 5MP IP Colour Smart Deep Learning External Turret Camera

The CVP9316DLCS-IP5M/2.8 model is a professional IP camera designed to provide high quality, full colour images in demanding external environments. This weather resistant external turret features a 2.8mm fixed lens with F1.0 super aperture iris, warm light LEDs with 20m illumination range, and can provide crisp 5-megapixel images with excellent colour accuracy. It also comes equipped with a full suite of Deep Learning video analytics features to reduce false alarms, as well as traditional alarm and audio inputs/outputs. This camera is designed for excellent compatibility with the Concept Pro range of network video recorders.



Colour Smart: 24/7 Full Colour Performance

This model combines an Enhanced Low Light image sensor, F1.0 super aperture iris-equipped lens, and built-in warm light LEDs with 20m illumination range to provide 24/7 colour video monitoring. The image sensor and lens allow for greater light capture in environments with ambient light. When ambient light is not sufficient for superior colour imaging, the built-in warm light LEDs automatically turn on to continue providing excellent video with true colour accuracy. In addition, an intelligent anti-overexposure algorithm is used to automatically adjust supplemental lighting levels depending on the environment and how close moving objects are to the camera, ensuring object details are visible even when moving closer to the camera.

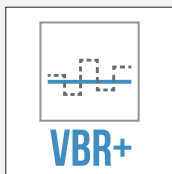

Intelligent, Efficient Bit Rate Control

Reduce camera streaming bit rates by up to 90% by using Variable Bit Rate (VBR) or VBR+ smart bit rate control settings. These dynamic features maximise overall image quality while minimising camera stream bit rates. This results in lower network bandwidth usage and extended recording storage retention time.

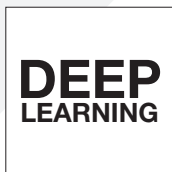

Deep Learning Video Analytics

Reduce false motion detection alarms by up to 95% using new Deep Learning technology. Trained with powerful deep learning algorithms, the camera can detect and classify human, car, and bicycles based upon specific line/zone and timing criteria. As a result, false alarms from sources such as lights, animals, foliage, weather, and other objects are effectively filtered and reduced. Additionally, this camera supports Deep Learning Motion Detection with human classification to reduce false alarms on traditional motion detection events.

KEY FEATURES

- ◆ Max. 25FPS @ 5MP
- ◆ 2.8mm Fixed Lens
- ◆ F1.0 Super Aperture
- ◆ 24/7 Full Colour Image
- ◆ 20m Warm Light Illumination
- ◆ Deep Learning Video Analytics & Deep Learning Motion Detection
- ◆ Alarm & Audio I/O

OTHER FEATURES

- ◆ PoE/DC12V Power Input
- ◆ True WDR, ATW, BLC, Defog, 3D-DNR
- ◆ VBR+ Smart Bit Rate Control & ROI
- ◆ ONVIF Profile S Compliant
- ◆ IP66-rated

COMPATIBLE WITH



CONCEPT PRO IP RECORDING RANGE

CVP9316DLCS-IP5M/2.8

Concept Pro 5MP IP Colour Smart
Deep Learning External Turret Camera

SPECIFICATION

Model/Feature	CVP9316DLCS-IP5M/2.8	
Video Output Type	IP	
Image Sensor	1/2.8" Progressive Scan CMOS	
Signal System	PAL/NTSC	
Min. Illumination	24/7 Full Colour Performance Colour: 0.003 lux @ F1.0, AGC ON; 0 lux with warm light LEDs ON	
Camera	Electronic Shutter	Auto/Manual, 1/25 to 1/5,000s
	S/N Ratio	≥48dB
	Warm Light LEDs	x2
	Warm Light Illumination Range	Max. 20m
	LED Control	Auto/Manual/Off with Anti-Overexposure
	Adaptable LED's	Auto
	Pan/Tilt/Rotation Range	P: 0°-349°, T: 0°-80°, R: 0°-360°
Lens	Lens Type	Fixed Lens
	Mount Type	Built-in
	Focal Length	f=2.8mm
	Aperture	F1.0
	Angle of View	H: 106.8°, V: 55.3°, D: 126.5°
Video	Focus	Fixed Focus
	Iris	Fixed Iris
	Compression	H.265/H.264 with VBR+ Smart Codec Option
	Streaming Capability	Triple Streaming + SVC Stream
	Resolution	2592x1944, 2592x1520, 2304x1296, 2048x1536, 1920x1080, 1280x1024, 1024x768, 1280x720, 704x576, 704x480, 640x480, 640x360, 352x288, 352x240
	Frame Rate	Stream 1: Max. 25FPS @ 2592x1944 Stream 2: Max. 25FPS @ 640x480 Stream 3: Max. 25FPS @ 640x480
	Bit Rate Control	CBR/VBR/VBR+
	Bit Rate	Stream 1: 1,000-8,000kbps Stream 2: 600-2,000kbps Stream 3: 600-2,000kbps
	Day/Night	True D&N with ICR (Auto/Day/Night/Schedule)
	Backlight Compensation	Yes
	Wide Dynamic Range	True WDR
	White Balance	ATW/Manual (Indoor/Fluorescent/Outdoor)
	Gain Control	Auto
	Noise Reduction	3D-DNR (Auto/Manual)
	Region of Interest	Manual (Max. 8 Regions)
	Defog	Yes
	Slow Shutter	Off/X2/X4/X8
	Image Setting	Mirror/Flip
	Image Adjustment	Brightness, Contrast, Colour, Sharpness
	Privacy Masking	Yes (Max. 4 Areas)
Motion Detection	Yes (Max. 4 Areas)	
Tamper Detection	Yes	
Deep Learning Motion Detection	Yes (Human Classification)	
Deep Learning Video Analytics	Yes (Human/Vehicle/Bike Classification; Intrusion, Line Crossing, Region Enter/Exit, Loitering, Stopping, Counter Detection) *Compatible with select Concept Pro NVRs	
Network	Transmission Distance	Max. 100m over Ethernet
	Ethernet	x1 RJ45 10M/100M Ethernet
	Protocol	IPv4, IPv6, IGMP, ICMP, ARP, TCP, UDP, DHCP, RTP, RTSP, RTCP, DNS, DDNS, NTP, SMTP, FTP, UPnP, HTTP, HTTPS, SSL/TLS
	Interoperability	ONVIF Profile S, HTTP/RTSP API
Interface	ONVIF Channels	Max. 4 Streams
	Streaming Method	Unicast/Multicast
	Max. User Access	x10
	Edge Storage	Local PC (Snapshot/Recording)
	Video Interface	-
	Alarm Interface	Alarm In x1, Alarm Out x1
	Audio Interface	Audio In x1 (RCA), Audio Out x1 (RCA)
	Audio Compression	G.711u-law (8kHz)
	RS-485	-
	Control Protocol	N/A
General	Reset Button	Yes
	Power Supply	PoE 802.3af (Class 0)/DC12V
	Power Consumption	PoE: Max. 7.9W with Warm Light on
	Power Output	-
	Operating Temperature	-20°C to +50°C
	Operating Humidity	0% to 90%
	Ingress Protection	IP66
	Vandal Resistance	-
	Housing Materials	Aluminum Diecasting RAL9010 Pure White
	Dimensions	(Ø) 120mm × (H) 94.8mm
Certification	Net Weight	≈700g
	Gross Weight	≈850g
Certifications	CE	

DIMENSIONS

All measurements are in mm.

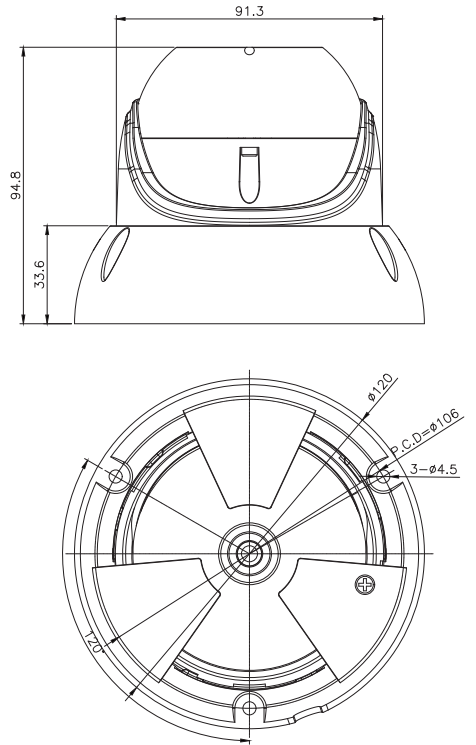

ORDER CODE

- **CVP9316DLCS-IP5M/2.8** Concept Pro 5MP IP Colour Smart Deep Learning External Turret Camera

OTHER PRODUCTS IN THE RANGE

- **CVP9316DEIREL-IP5M/2.8** Concept Pro 5MP IP Enhanced Low Light Fixed External Turret Camera
- **CVP9316DEIREL-IP5M-Z** Concept Pro 5MP IP Enhanced Low Light Motorised External Turret Camera
- **CVP9316DEIREL-IP5M-G/2.8** Concept Pro 5MP IP Enhanced Low Light Fixed External Turret Camera - Grey
- **CVP9316DEIREL-IP8M/2.8** Concept Pro 8MP IP Enhanced Low Light Fixed External Turret Camera
- **CVP9316DEIREL-IP8M-G/2.8** Concept Pro 8MP IP Enhanced Low Light Fixed External Turret Camera - Grey

RECOMMENDED ACCESSORIES

- **CP-BASE-1-V2** Concept Pro Small Junction Box
- **CP-WM-1-V2** Concept Pro Small Wall Mount
- **CP-PM-1-V2** Concept Pro Small Pendant Mount
- **CP-PLM-V2** Concept Pro Pole Mount
- **CP-CM-V2** Concept Pro Corner Mount
- **CAT6-305** 305m CAT6 Cable (Green)
- **VA-SW4/8/16POE-IP** 4/8/16 Channel PoE Switch

COMPATIBLE WITH



CONCEPT PRO
IP RECORDING
RANGE

CVP9316DLC-IP5M/2.8

Concept Pro 5MP IP Colour Smart
Deep Learning External Turret Camera

ACCESSORIES

DIMENSIONS

CP-BASE-1-V2

Concept Pro Small
Junction Box

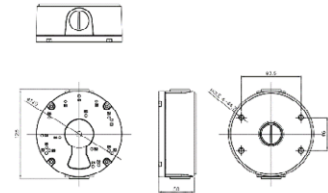

CP-PM-1-V2

Concept Pro Small
Pendant Mount

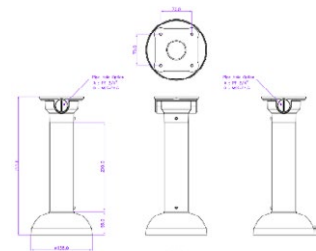
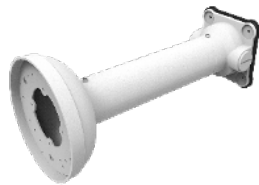

CP-WM-1-V2

Concept Pro Small
Wall Mount

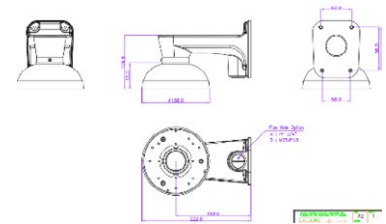
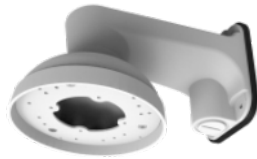

CP-PLM-V2

Concept Pro Pole Mount
(can be combined with
CP-BASE-1-V2
or CP-WM-1-V2)

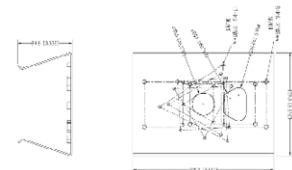

CP-CM-V2

Concept Pro Corner Mount
(can be combined with
CP-BASE-1-V2)

